



SIEMENS

Ingenuity for life

Siemens PLM Software

What they didn't teach you in school about pressure drop

Mechanical analysis

Introduction

In the design of many products, pressure and its loss are the most important considerations. After all, a pressure drop translates to a loss in energy which would have to be compensated by a higher energy demand. Therefore, it stands to reason that an optimized design resulting in the optimal pressure conditions, would result in energy savings.

Also as we all remember from school, there are many types of pressure – static, dynamic, total and potential pressure. On top of that, how does the actual fluid behave? Is it incompressible? Does it have any friction? What's the fluid density?

While it's easy to look-up the various formulas that can help us figure this out, it's not always easy to apply them when you're designing a complex product and need to calculate the pressure drop. That's where computational fluid dynamics (CFD) comes into play. CFD can be one of the most important design tools available to a design engineer as it can help you understand trends in your design and separate models with potential from the poor ones.

Best ROI is achieved by simulating early: Frontloading analysis in the design process

Unfortunately, CFD is not always taught rigorously as a part of an undergraduate program. And even when it's done, it's only used for a couple of simple problems. Furthermore, until recently, the commercial software available for CFD has typically been geared towards specialists, limiting its widespread use. Besides being overly expensive, these tools have either been difficult, cumbersome or time-consuming to use. As a result, engineering analysis for applications such as pressure drop traditionally have been carried out by specialists in analysis departments, separate from mainstream design

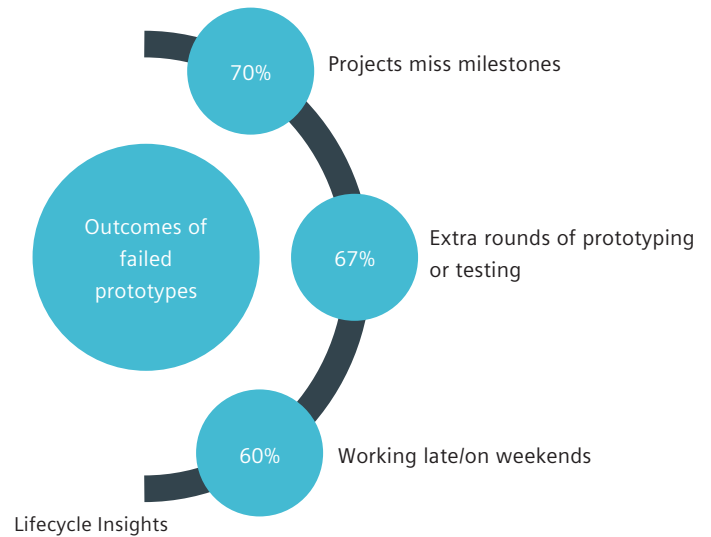

and development departments. To test or verify their designs, mechanical engineers therefore had to rely on creating physical prototypes and testing them on a flow bench or test rig.

However, testing a design only at the prototype stage is costly. According to a report by Lifecycle Insights [1], at this stage, failed designs lead to missing project milestones, extra rounds of testing, and having to work long hours.

Reducing the cost of change and building in more room for cost reductions provides the most significant return on investment (figure 1) [2]. Prof. Martin Eigner coined "frontloading" as an umbrella term for the practice of using a whole slew of software simulation tools, including CFD, earlier in the design process [2].

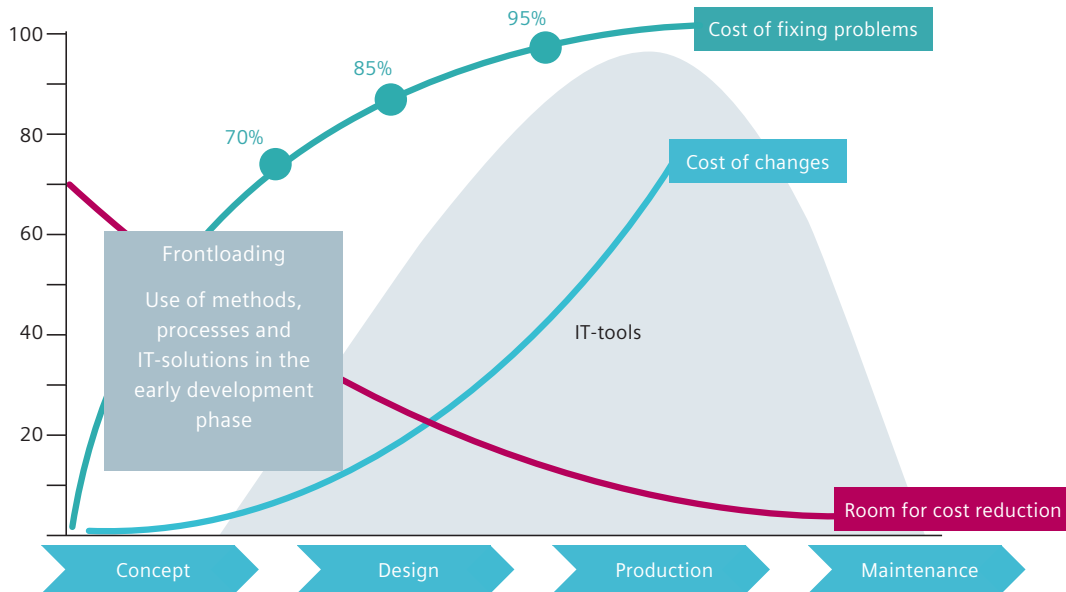

Source: Prof. Dr. Martin Eigner VPE TU Kaiserslautern

Figure 1: Frontloading of simulation can help reduce costs

Multiple surveys conducted by various industry analysts and CAE vendors suggest that the most successful companies assess performance of their designs early during the development process and actively promote collaboration and sharing of knowledge between analysis experts and design engineers.

How frontloading CFD has changed the design process

About 20 years ago, stress analysis was introduced for use during the early design stages, and it quickly became an integral step in the development process. Now, all major MCAD software tools provide design-level, stress simulation. However, frontloading stress simulation and conducting analysis early during the design stage did not mean that manufacturers stopped simulating during the validation stage.

Simulation simply became a method by which trends were examined and less desirable design ideas were dismissed earlier.

Unlike the verification stage, speed is of the essence during the design phase. Engineers need to simulate, not only early, but often to keep in step with the speed of design changes. By iterating rapidly, engineers can discount the less attractive ideas and innovate further. Once a design has been explored and identified as viable, it can continue on to the verification stage.

This practice has spread to other areas including CFD analysis. We now have CFD tools that are designer-friendly and are linked integrally and conveniently within CAD tools. Using these combined tools, a prototypical digital twin — a virtual representation of the product — can be created.

The benefits of frontloading CAD-embedded CFD include:

- Lowered product development costs
- Decreased time-to-market
- More innovative and better-performing products
- Removal of a major operational bottleneck in the design process
- Reduced operational risk due to compliance with increasingly strict regulations

Why frontloading requires simulation inside CAD

Traditional CFD software programs tend to have their own proprietary interfaces that are not embedded in CAD; at best, they offer data translators to move models from CAD to CFD software. Therefore, every time a model needs to be analyzed, the data has to be prepared and exported out of CAD and imported into the CFD tool where the model can be “healed” for use.

Also, they are crammed with technology that requires advanced training and education, which is why dedicated analysts are usually assigned the task. For example, most traditional CFD tools support many mesh types. The user has to know which one would be the most appropriate for the specific application, physics and flow type. In addition, he or she will have to work on the mesh until an optimal mesh for the model and application has been achieved. In short, using traditional CFD tools can be extremely time-consuming and slower than is desired during the design stage. As a result of this specialization, the work of analyzing the pressure aspects of a design that affect critical product operation has been separated from the design and development departments.

In contrast, designer-friendly CFD solutions:

- Must be fully embedded in CAD: These tools can be easily accessed inside the CAD program, and they use the same native geometry for analysis. Exporting data in preparation for analysis is no longer required. In addition, the software simply slots in — no learning of a completely new interface is required. CFD analysis simply becomes another functionality offered by the CAD package
- Intelligent automation: CAD-embedded CFD programs need to have built-in intelligent automation for easier, faster, and more accurate analysis. For example, when considering fluid flow problems, sometimes a designer is interested in understanding what is happening in the empty space where the fluid resides. With traditional CFD, additional geometry has to be created to represent that cavity. CAD-embedded CFD solutions, on the other hand, are intelligent enough to recognize that the empty space is the fluid domain so that no time is wasted creating geometry to accommodate software.

Also, before analysis can begin, the model has to be meshed. With traditional CFD, the engineer has to be fully conversant in which meshing method best depicts the flow phenomenon. CAD-embedded CFD uses a fully automated mesher that will automatically generate the best possible mesh for the problem being set up

- Combined speed with accuracy: CFD solutions that can truly be used inside CAD and frontloaded in the design process can reduce the overall simulation time significantly — some organizations have reported time compression of up to 75 percent and improved productivity of up to x40

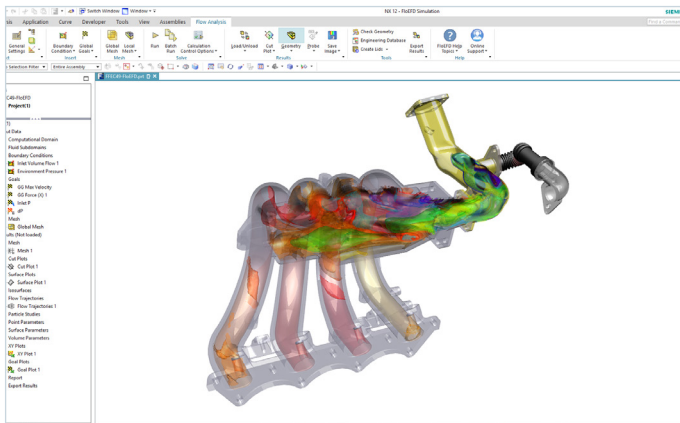

Simcenter FLOEFD for NX

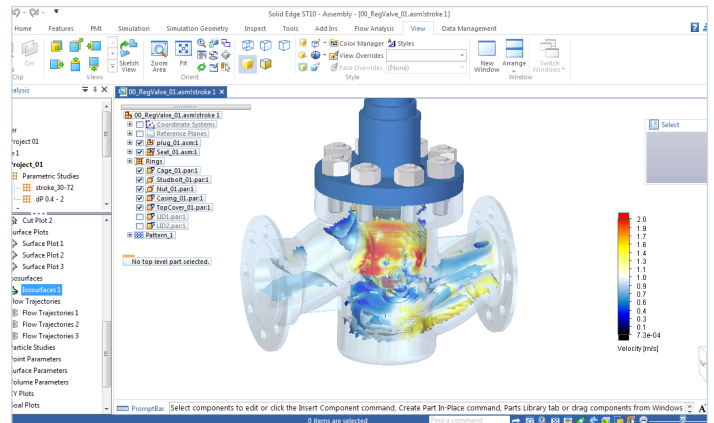

Simcenter FLOEFD for Solid Edge

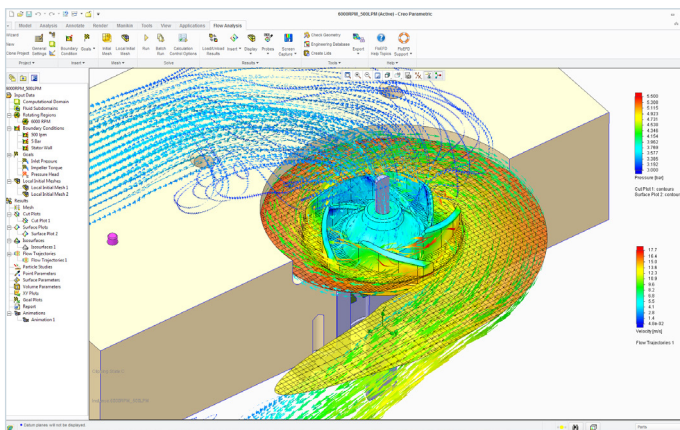

Simcenter FLOEFD for PTC Creo

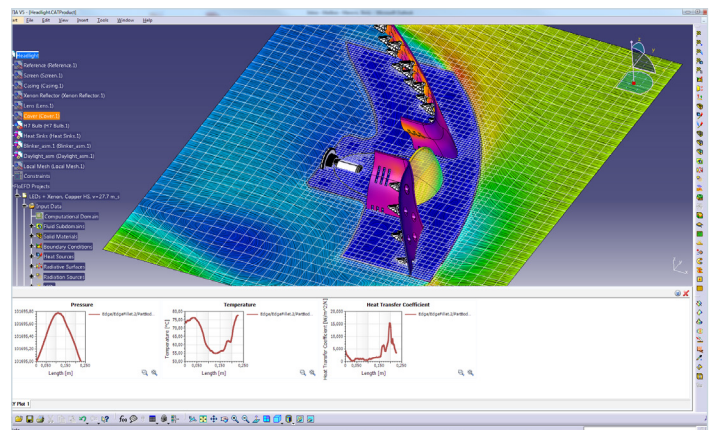

Simcenter FLOEFD for CATIA V5

Figure 2. Simcenter FLOEFD is embedded into popular MCAD programs.

The leading frontloading CFD solution

Simcenter FLOEFD™ software is embedded in MCAD toolsets such as CATIA® V5, Creo™ Elements/Pro™, NX™ and Solid Edge®. With Simcenter FLOEFD, designers can focus on analyzing the details of pressure distribution in the fluid and its load on the solid of their products. What-if scenarios can be run to analyze complex physical relations such as between the pressure drop and flow rate.

Simcenter FLOEFD combines all phases of pressure drop analysis in one package, from 3D modelling, to problem set-up, running, results visualization, validation, and reporting. Typical pressure drop applications include flows through valves, manifolds, heat exchangers, filtration systems, electronics enclosures and ducting; in fact any system where the goal is to reduce the

amount of energy required to move flow or to maximize its capacity.

With Simcenter FLOEFD, designers can focus on analyzing in detail why the flow of gas or liquid may be at a higher or lower pressure than that allowed in the technical specification. All the designer needs is knowledge of the MCAD system and the physics of the product they are designing. After installation of Simcenter FLOEFD, all the menus and commands necessary to run a full CFD flow analysis are created in the familiar CAD package's menu system. This close interaction between the MCAD system and Simcenter FLOEFD makes it extremely easy to use. In fact, most designers are ready to use Simcenter FLOEFD with less than eight hours of training.

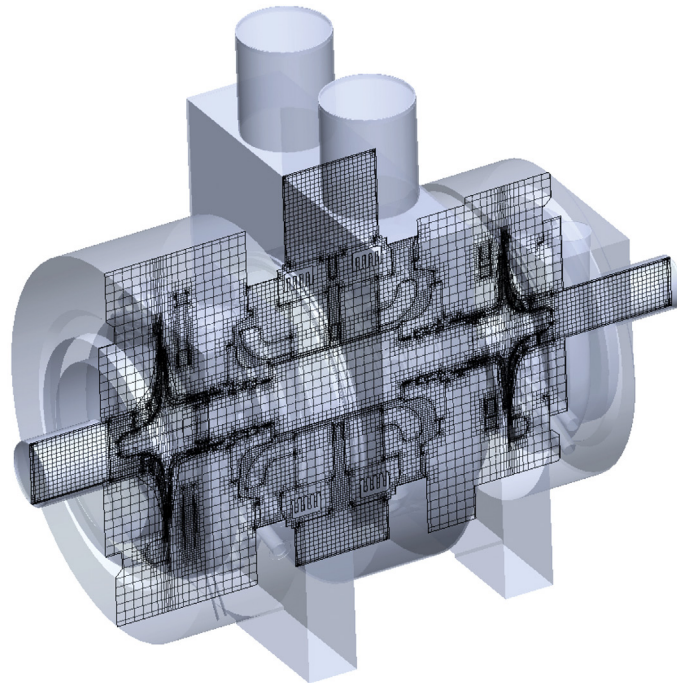

Figure 3: SmartCells make it possible to use coarser mesh for fast analysis without sacrificing accuracy.

Now the most common engineering task for fluid flow applications is to minimize the pressure losses in a system as a fluid flows from point A to point B. The basic engineering challenge is to either maximize the flow rate for a given pressure drop or minimize the pressure drop for a given flow rate. If the flow is driven by a pump or fan, then understanding the pressure drop enables the designer to optimize the size of the fan or pump.

The starting point of any flow analysis is to clearly describe the geometry of the mechanical system. Simcenter FLOEFD lets a designer take advantage of existing MCAD models for analysis, without having to export or import additional data, saving significant amounts of time and effort. The embedded Simcenter FLOEFD toolset can use newly-created or existing 3D CAD geometry and solid model information to simulate designs in real-world conditions. Simcenter FLOEFD recognizes the appropriate fluid region based on the empty internal spaces within the solid model, where the designer has placed boundary conditions.

Simcenter FLOEFD can also analyze a range of fluids. This includes gases — starting with the subsonic

regime up through transonic, supersonic, and hypersonic flow — liquids and non-Newtonian fluids such as plastic flows, as well as flows for food processing applications. Even steam flow can be simulated. There is also a two-phase cavitation model and a combustible mixture and free surface simulation.

Once a model is created, it needs to be meshed. Developing a mesh is one of those skills that previously separated CFD specialists from mechanical engineers. With Simcenter FLOEFD, the base mesh is created automatically in a matter of minutes rather than requiring hours of tedious proportioning of regions and cells. Simcenter FLOEFD creates meshes automatically in minutes. CAD-embedded CFD creates an adaptive mesh that reduces the cell size where necessary, increasing the resolution of the analysis, to ensure more accurate simulation results in complex areas of the model (figure 3). For additional information about this meshing technology called SmartCells, please read SmartCells – Enabling Fast and Accurate CFD - www.mentor.com/products/mechanical/resources/overview/smartcells-enabling-fast-accurate-cfd

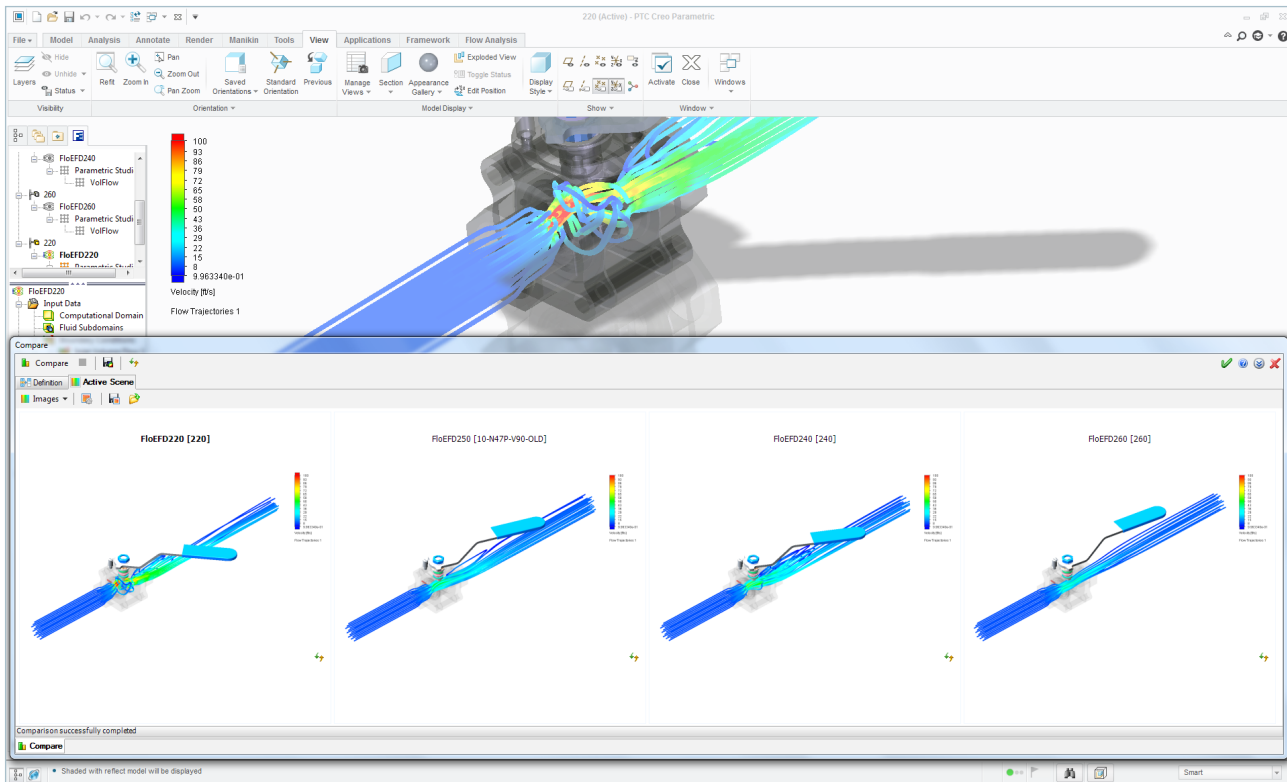

Figure 4: The compare configuration and parametric study capability inside Simcenter FLOEFD enables engineers to understand the influence of changes in the geometry or boundary conditions on the results.

Solving advanced pressure drop challenges

Simcenter FLOEFD provides an extensive ability to visualize what is happening to a design's flow, giving the engineer valuable insight that can guide design decisions. The visualization capabilities allow users to interrogate the design more thoroughly and visualize the flow within the native CAD environment.

For example, when analyzing pressure drop there are often many flow passages much smaller in scale than the majority of the device. A valve design, for instance, might include a perforated insert with small holes that the flow must move through. Capturing this somewhat complex geometry and re-meshing it between successive design iterations would be a tedious task using a traditional CFD tool and would require advanced meshing knowledge. In contrast, using the auto-mesher in Simcenter FLOEFD the designer can easily enter the size of the perforated holes to guide the mesher in creating the correct size of the flow channels. A quality mesh

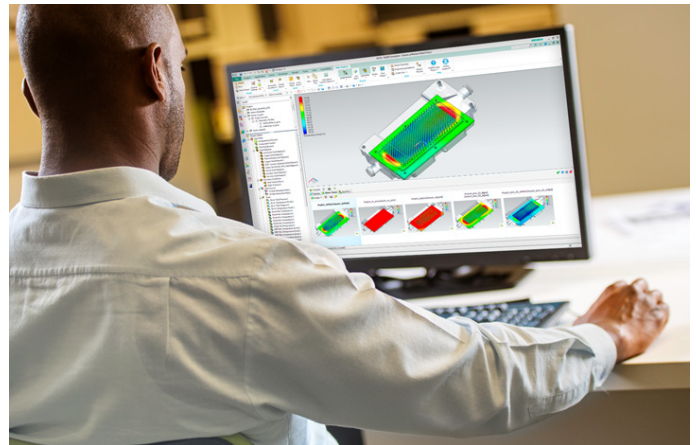

Figure 5: Simcenter FLOEFD parametric study and design comparison functionality helps engineers optimize designs quickly.

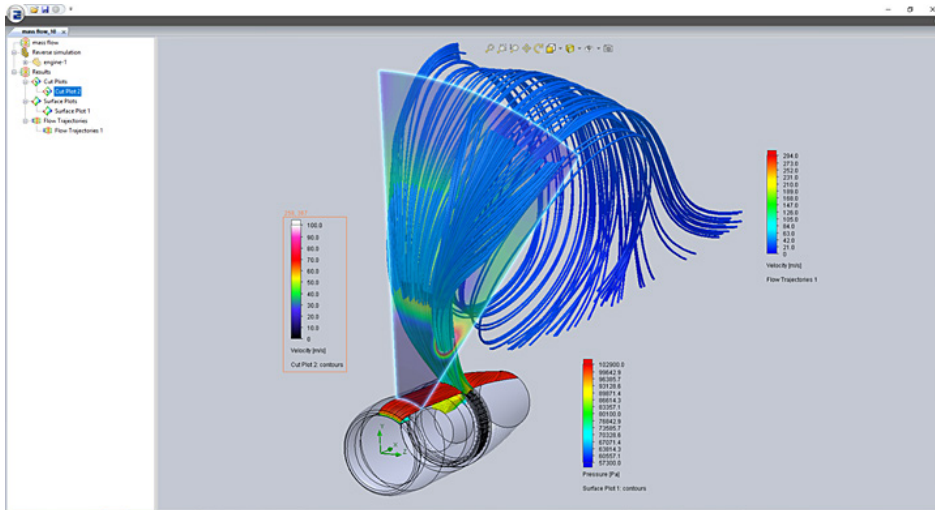

Figure 6: Simcenter FLOEFD Viewer is a free standalone viewer for sharing selected result plots with customers in an interactive 3D environment rather than a 2D image.

that will give accurate answers will be automatically generated, enabling the designer to efficiently evaluate the impact on the overall performance of the system.

A two-dimensional way to examine the flow field in Simcenter FLOEFD is to use a cut plot, which depicts the flow on a plane through the model. A cut plot of results can be displayed with any results parameter and the representation can be created as a contour plot, ISO lines, or as vectors. It can also be created in any combination such as velocity magnitude, and velocity vectors. In addition to cut plots, a 3D surface plot can be easily displayed for any particular face as well as automatically for the entire flow domain.

Simcenter FLOEFD also offers a powerful way to examine yet another parameter of interest in pressure drop analysis: total pressure. In real viscous flows, there are losses in total pressure as the fluid flows through design contours. So areas of total pressure gradients indicate places where there are viscous losses of energy that cannot be recovered.

Solving any of these pressure flow problems is an iterative process. After seeing the initial analysis results, most designers want to modify their models to explore different scenarios to see if they can optimize the flow. Simcenter FLOEFD makes it easy to conduct these “what-if” analyses. Designers can explore design

alternatives, detect design flaws, and optimize product performance before detailed designs or physical prototypes are created.

This allows the designer to determine quickly and easily which designs have promise, and which designs are unlikely to be successful.

To examine alternatives, the designer simply creates multiple clones of the solid model in Simcenter FLOEFD that automatically retain all project definitions including goals and material properties. When the engineer modifies a solid model, he or she can immediately analyze it.

The software also aids in parametric optimization — for example, automatically running a design-of-experiments with various design parameters to determine for example the optimal thickness. In these ways, Simcenter FLOEFD accelerates the iterative design process, allowing engineers to quickly and easily incorporate knowledge gained in an analysis into an improved design.

Simcenter FLOEFD provides robust verification capabilities for validating designs. Before releasing a new version of Simcenter FLOEFD, Mentor engineers validate

the release with a suite of 300 tests. Based on this rigorous verification suite, Simcenter FLOEFD offers 20 tutorial and 32 validation examples, including their documentation, ready for immediate use. For example, designers could use these examples to validate the flow in 2D channels with bilateral and unilateral expansions and parallel walls. Or they could verify the classic pressure drop benchmark for CFD: the flow in a 90-degree bend of a 3D square duct or through a cone valve.

And its compare configuration and parametric study capability enables users to understand the influence of changes in the geometry or boundary conditions on the results. Users can evaluate the design envelope by assessing results by numerical values, by graphs and by visual images/animation; thereby compare a wide range of project permutations. In these ways, Simcenter FLOEFD accelerates the iterative design process, allowing knowledge gained in a simulation to be quickly and easily incorporated to improve the product.

Sharing results and findings is simple. Simcenter FLOEFD is fully integrated with Microsoft® Word® and Excel®, allowing engineers to create report documents and collect important data in graphical form from any project. In addition, it automatically creates Excel spreadsheets summarizing the outputs of an analysis; thus making the last step in any analysis, creating reports, effortless.

Using Simcenter FLOEFD, designers can easily pinpoint sections of interest and focus their efforts on improving them to optimize the overall flow of the design and share the results with their customers and manager using the free of charge Simcenter FLOEFD Viewer. The free standalone viewer lets users share selected result plots with non-Simcenter FLOEFD users in an interactive 3D environment rather than a 2D image or even animation.

Simcenter FLOEFD is the ideal solution for designers interested in solving pressure related problems inside their CAD platform of choice.

Real world designers solving real design challenges

Read how engineers have already used Simcenter FLOEFD to solve real-world engineering challenges, meet tight deadlines, achieve higher quality results, and keep costs to a minimum:



Mitsubishi materials corporation uses Simcenter FLOEFD to design liquid-cooled nozzles for cutting tools

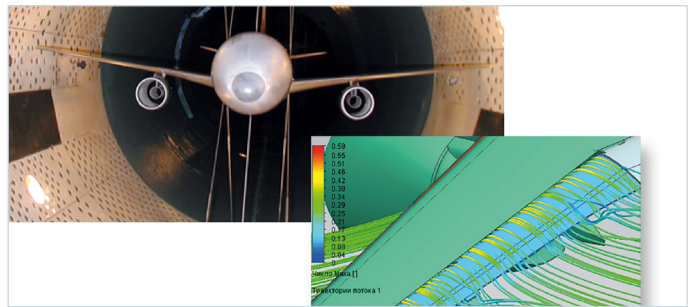

Winging it! Simcenter FLOEFD provides accurate and fast flight load data for aircraft wing high lift devices at Irkut

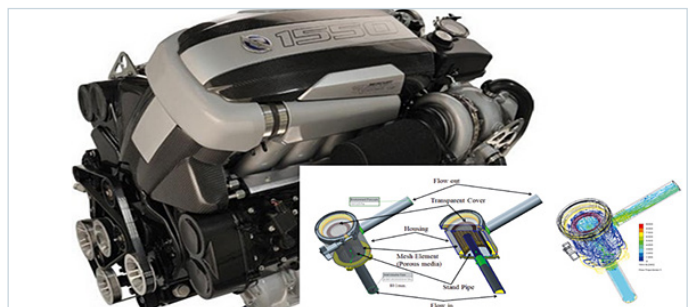

Mercury Racing® use Simcenter FLOEFD in the design of their latest intercooler filter

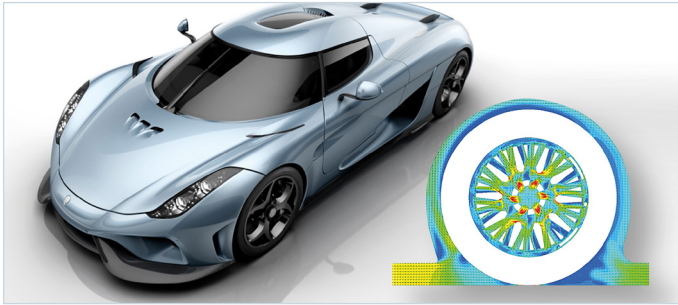

Sports car brake cooling simulation with CAD-embedded CFD

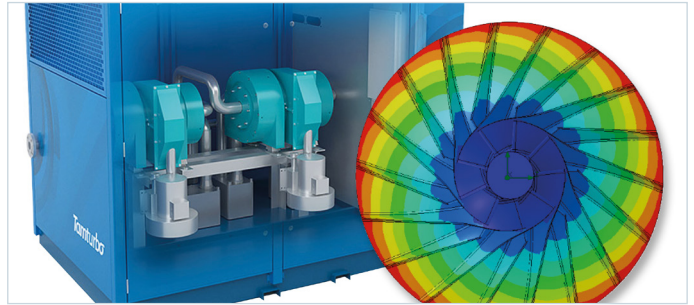

Air dynamics simulation of the tamturbo oil-free air turbo compressor

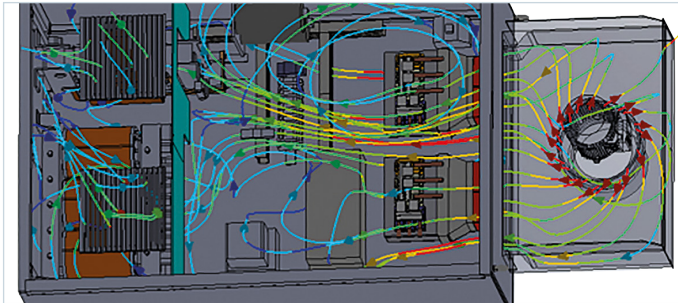

Cooling power electronics at room level

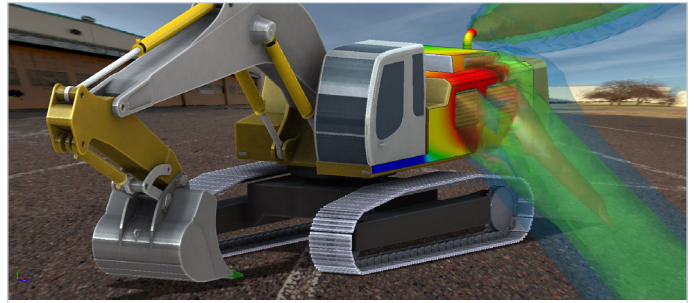

Liebherr-Werk Nenzing GmbH use Simcenter FLOEFD in their mobile harbor crane designs

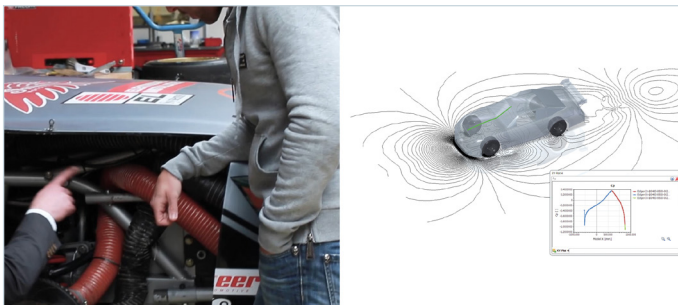

Optimizing a NASCAR racing machine

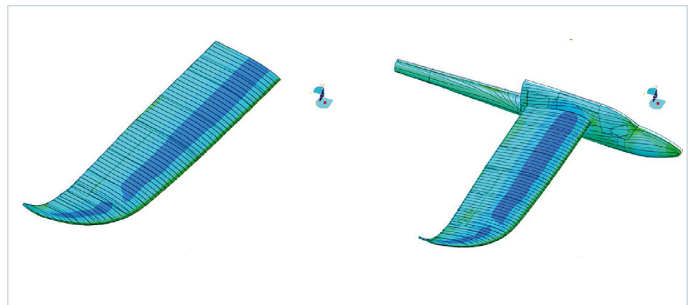

Up, up and away - Using CFD tools to develop a real-time flight model

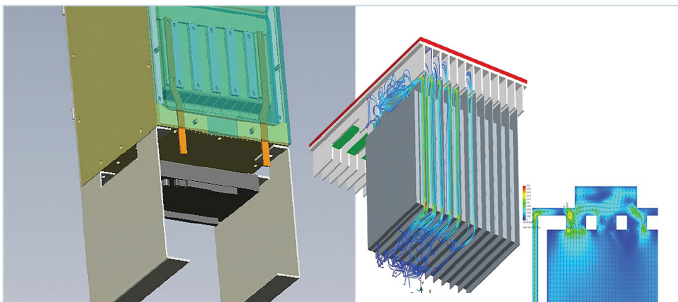

Driving flanders to electric powertrain innovation

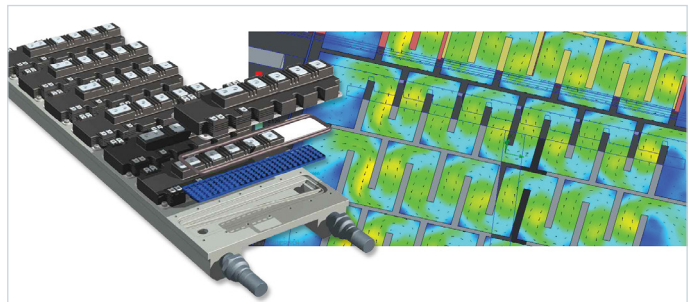

Simcenter FLOEFD efficiently cools IGBT power modules



Engineering techniques for a helicopter rotor simulation

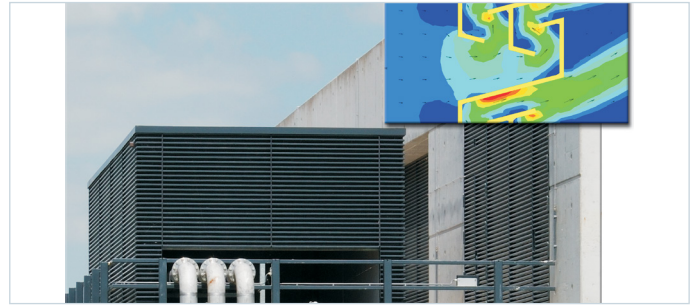

Jazo Zevenaar saves three weeks in the design of protective housings

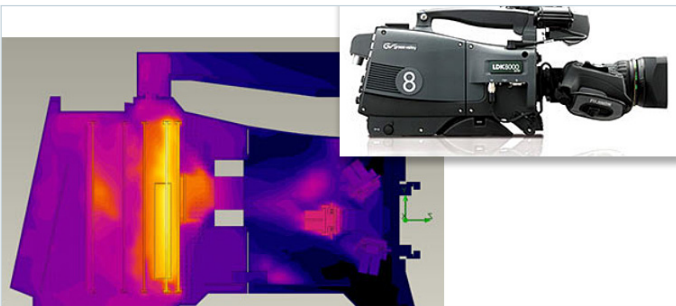

Grass valley makes Simcenter FLOEFD an integral part of product development process

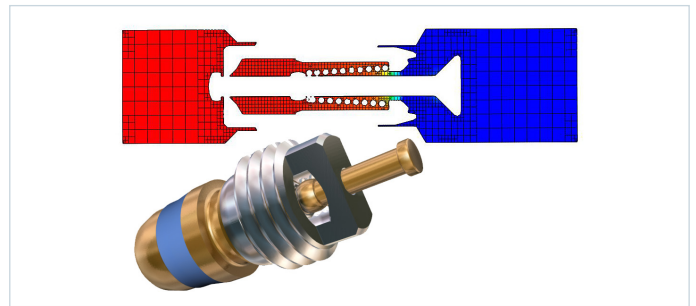

Ventrex saves four months in design of automotive valve

References

1. 2013. Driving Design Decisions with Simulation. Lifecycle Insights.
2. 2010. Eigner, M. Future PLM – Trends aus Forschung und Praxis: University of Kaiserslautern Blog

Siemens PLM Software

Headquarters

Granite Park One
5800 Granite Parkway
Suite 600
Plano, TX 75024
USA
+1 972 987 3000

Americas

Granite Park One
5800 Granite Parkway
Suite 600
Plano, TX 75024
USA
+1 314 264 8499

Europe

Stephenson House
Sir William Siemens Square
Frimley, Camberley
Surrey, GU16 8QD
+44 (0) 1276 413200

Asia-Pacific

Suites 4301-4302, 43/F
AIA Kowloon Tower,
Landmark East
100 How Ming Street
Kwun Tong, Kowloon
Hong Kong
+852 2230 3333

About Siemens PLM Software

Siemens PLM Software, a business unit of the Siemens Digital Factory Division, is a leading global provider of software solutions to drive the digital transformation of industry, creating new opportunities for manufacturers to realize innovation. With headquarters in Plano, Texas, and over 140,000 customers worldwide, Siemens PLM Software works with companies of all sizes to transform the way ideas come to life, the way products are realized, and the way products and assets in operation are used and understood. For more information on Siemens PLM Software products and services, visit www.siemens.com/plm.

www.siemens.com/plm

© 2018 Siemens Product Lifecycle Management Software Inc. Siemens and the Siemens logo are registered trademarks of Siemens AG. Femap, HEEDS, Simcenter 3D and Teamcenter are trademarks or registered trademarks of Siemens Product Lifecycle Management Software Inc. or its subsidiaries in the United States and in other countries. Simcenter, Simcenter Amesim, LMS Samtech Samcef, LMS Samcef Caesam, Simcenter SCADAS, Simcenter Testxpress, Simcenter Soundbrush, Simcenter Sound Camera, Simcenter Testlab, LMS Virtual.Lab, Simcenter Simcenter FLOEFD, Simcenter Flomaster, Simcenter Flotherm, Simcenter MAGNET and Simcenter T3STER are trademarks or registered trademarks of Siemens Industry Software NV or any of its affiliates. Simcenter STAR-CCM+ and STAR-CD are trademarks or registered trademarks of Siemens Industry Software Computational Dynamics Ltd. All other trademarks, registered trademarks or service marks belong to their respective holders.

75930-A7 11/18 Y